





Monomando ducha mural horizontal de 2 vías / Wall-mounted shower mixer 2 ways / Mitigeur de douche mural 2 voies

Acabados / Finishes / Finition / Acabamento / Finitura

 Cromado Chromed Chromé Cromado Cromato CR	 Negro mate Black matt Noir mat Preto mate Nero opaco BM	 Metal gun Metal gun Metal gun Metal gun Metal gun MG
 Níquel cepillado Nickel brushed Nickel brossé Níquel escovado Nichel spazzolato NB	 Oro cepillado Brushed gold Or brossé Ouro escovado Oro spazzolato BG	 Oro rosa cepillado Brushed rose gold Or rose brossé Ouro rosa escovado Oro rosa spazzolato RG



Características / Features / Caractéristiques / Características / Caratteristiche

 Monomando Mixer Mitigeur Torneira Monocomando	 2 vías 2 ways 2 voies 2 caminhos 2 vie
 Teleducha de latón Brass handshower Douchette à main en laiton Chuveiro de mão de latão Doccetta in ottone	 Flexo 1,5m PVC 1,5 m PVC hose Flexible 1,5m PVC Mangueira de chuveiro 1,5m PVC Flessibile 1,5m PVC

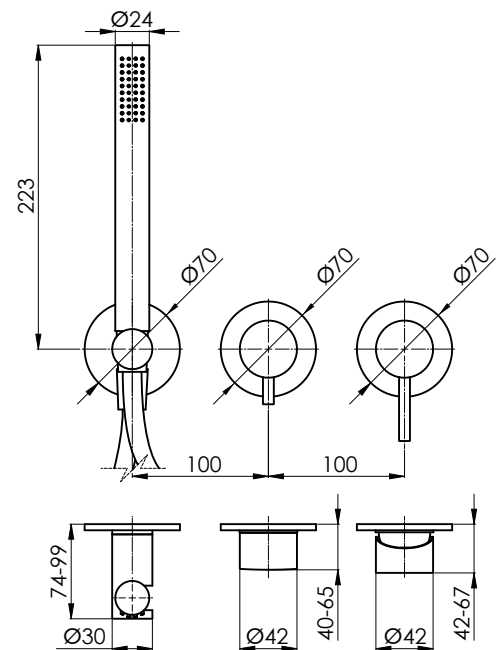

Caudal / Flow rate / Débit / Fluxo / Flusso

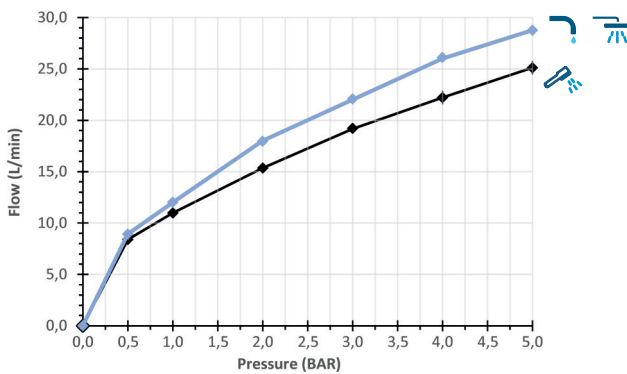

Pressure (BAR)	0	0,5	1	2	3	4	5
Flow rate (l/min)	0	8,3	11,3	15,9	19,1	22,6	25,5
Flow rate (l/min)	0	9,2	13	18,6	22,8	26,2	28,7

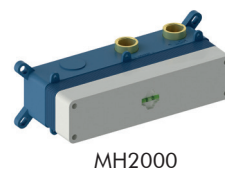

Debe acompañarse con el cuerpo de empotrar **sanybox** correspondiente.
Must be accompanied by the corresponding concealed body **sanybox**.
Doit être accompagnée du corps encastré **sanybox** correspondant.
Deve ser acompanhado com o corpo de incorporação **sanybox** correspondente.
Deve essere accompagnato dal corpo da incasso **sanybox** corrispondente.

ref.	P kg	P' kg	V cmxcmxcm
MH2D001..	1,10	1,33	30,3x13,8x7

P: Peso neto / Net weight / Poids net / Peso líquido / Peso netto

P': Peso de expedición / Expedition Weight / Poids d'expédition / Peso do expedição / Peso spedizione

V: Volumen de expedición / Expedition Volume / Volume d'expédition / Volume do expedição / Volume spedizione