





Monomando ducha mural horizontal de 2 vías / Wall-mounted shower mixer 2 ways / Mitigeur de douche mural 2 voies

Acabados / Finishes / Finition / Acabamento / Finitura

	Cromado Chromed Chromé Cromado Cromato		Negro mate Black matt Noir mat Preto mate Nero opaco		Metal gun Metal gun Metal gun Metal gun Metal gun
CR		BM		MG	
	Níquel cepillado Nickel brushed Nickel brossé Níquel escovado Nichel spazzolato		Oro cepillado Brushed gold Or brossé Ouro escovado Oro spazzolato		Oro rosa cepillado Brushed rose gold Or rose brossé Ouro rosa escovado Oro rosa spazzolato
NB		BG		RG	



Características / Features / Caractéristiques / Características / Caratteristiche

	Monomando Mixer Mitigeur Torneira Monocomando		2 vías 2 ways 2 voies 2 caminhos 2 vie
	Teleducha de latón Brass handshower Douchette à main en laiton Chuveiro de mão de latão Doccetta in ottone		Flexo 1,5m PVC 1,5 m PVC hose Flexible 1,5m PVC Manguera de chuveiro 1,5m PVC Flessibile 1,5m PVC

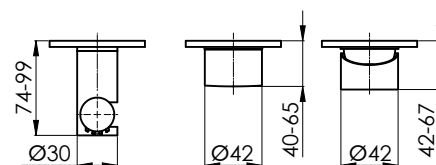
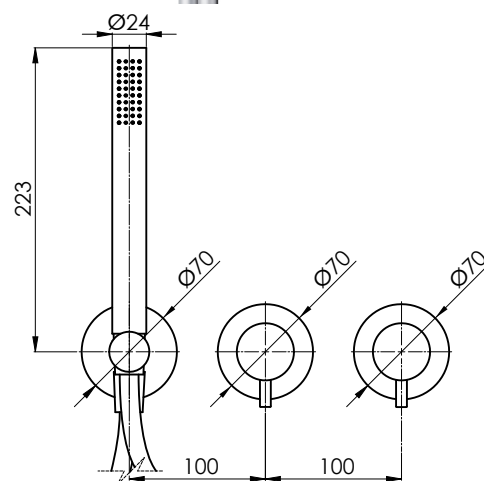

Caudal / Flow rate / Débit / Fluxo / Flusso

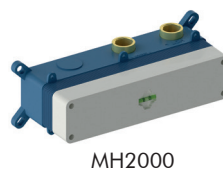
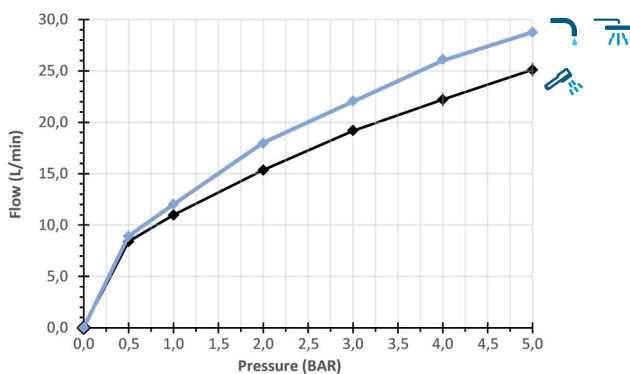

Debe acompañarse con el cuerpo de empotrar **sanybox** correspondiente.
Must be accompanied by the corresponding concealed body **sanybox**.
Doit être accompagnée du corps encastré **sanybox** correspondant.
Deve ser acompanhado com o corpo de incorporação **sanybox** correspondente.
Deve essere accompagnato dal corpo da incasso **sanybox** corrispondente.

ref.	P kg	P' kg	V cmxcmxcm
MH2D011...	1,10	1,33	30,3x13,8x7

P: Peso neto / Net weight / Poids net / Peso líquido / Peso netto

P': Peso de expedición / Expedition Weight / Poids d'expédition / Peso do expedição / Peso spedizione

V: Volumen de expedición / Expedition Volume / Volume d'expédition / Volume do expedição / Volume spedizione