







Termostático externo baño- ducha / Exposed bath-shower thermostatic mixer / Thermostatique de bain-douche extérieur / Termostática de banho-duche exposto / Termostatica esterno per bagno-doccia

Acabados / Finishes / Finition / Acabamento / Finitura

 Cromado Chromed Chromé Cromado Cromato	 Negro mate Black matt Noir mat Preto mate Nero opaco	 Metal gun Metal gun Metal gun Metal gun Metal gun
CR	BM	MG
 Níquel cepillado Nickel brushed Nickel brossé Níquel escovado Nichel spazzolato	 Oro cepillado Brushed gold Or brossé Ouro escovado Oro spazzolato	 Oro rosa cepillado Brushed rose gold Or rose brossé Ouro rosa escovado Oro rosa spazzolato
NB	BG	RG



Características / Features / Caractéristiques / Características / Caratteristiche

 Mezclador termostático Thermostatic mixer Melangeur thermostatique Torneira termostática Monocomando termostatica	 PVD con tratamiento antihuella Anti-fingerprint PVD PVD avec traitement anti-impronta PVD con trattamento anti-impronta PVD com tratamento anti-impressão digital
 Cartucho termostático VERNET® VERNET® thermostatic cartridge Cartouche thermostatique VERNET® Cartucho termostático VERNET® Cartuccia termostatica VERNET®	 Antirretornos NEOPERL® NEOPERL® check valves Anti-retours NEOPERL® Anti-retorno NEOPERL® Anti-ritorni NEOPERL®
 Teleducha de latón Brass handshower Douchette à main en laiton Chuveiro de mão de latão Doccetta in ottone	 Flexo 1,5m PVC 1,5 m PVC hose Flexible 1,5m PVC Manguera de chuveiro 1,5m PVC Flessibile 1,5m PVC

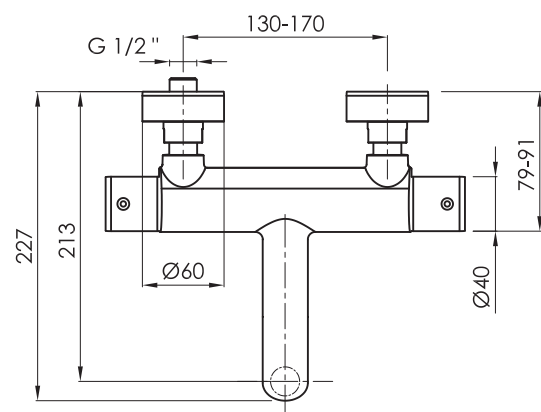
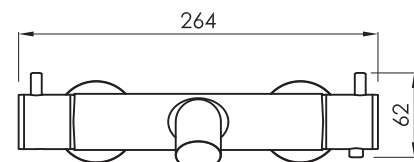

mm

Caudal / Flow rate / Débit / Fluxo / Flusso

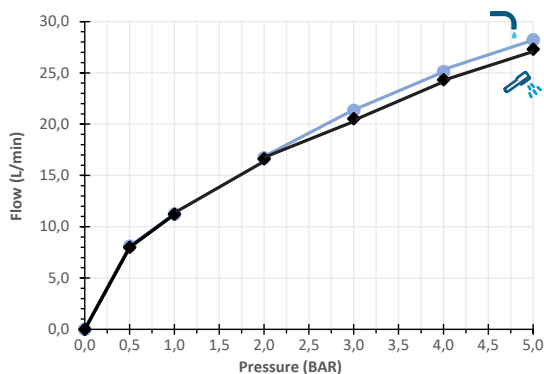

Pressure (BAR)	0	0,5	1	2	3	4	5
Flow rate (l/min) 	0	8,0	11,2	16,6	20,5	24,3	27,3
Flow rate (l/min) 	0	8,1	11,2	16,7	21,3	25,1	28,2

ref.	P kg	P' kg	V cmxcmxcm
TDB001..	1,60	1,90	23,5x22x6
TDB001..K	0,80	1,04	30x24x7

P: Peso neto / Net weight / Poids net / Peso líquido / Peso netto

P': Peso de expedición / Expedition Weight / Poids d'expédition / Peso do expedição / Peso spedizione

V: Volumen de expedición / Expedition Volume / Volume d'expédition / Volume do expedição / Volume spedizione